

## Square 16 2004 / 2016



### Divano in linea componibile e pouf

#### Materiali

STRUTTURA: acciaio e legno con cinghie elastiche.

PIEDINI: acciaio verniciato a polvere colore canna di fucile oppure legno massello di frassino tinto noce canaletto finito con vernice trasparente a base acqua o a base solvente. Sottopiede regolabile in materiale termoplastico.

IMBOTTITURA: poliuretano espanso a quote differenziate e ovatta di poliestere foderato con vellutino di poliestere. Per le versioni FR (Fire Resistant) a richiesta, i materiali dell'imbottitura sono come da normative.

VERSIONE PIUMA D'OCA: cuscino di seduta in piuma d'oca con supporto in poliuretano espanso, foderato con ovatta di poliestere e tela di cotone. Cuscino bracciolo in piuma d'oca con supporto in poliuretano espanso, foderato con tela di cotone. Cuscino schienale in piuma d'oca mista a fibra di poliestere, rivestito con tela di cotone.

VERSIONE MEMORY FOAM: cuscino di seduta in memory foam, poliuretano espanso e ovatta di poliestere, foderato con tela di cotone. Cuscino schienale e bracciolo in piuma d'oca mista a fibra di poliestere con supporto in poliuretano espanso, foderato con tela di cotone. Solo per il mercato UK le parti previste in memory foam vengono realizzate in poliuretano espanso.

RIVESTIMENTO: rivestimento tecnicamente sfoderabile in tessuto o fisso in pelle o velluto.

+info:

<http://www.depadova.com/materials.pdf>

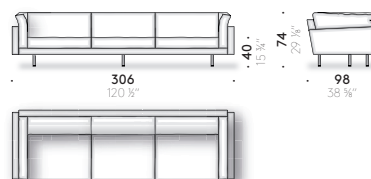
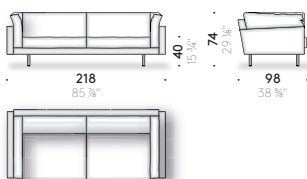
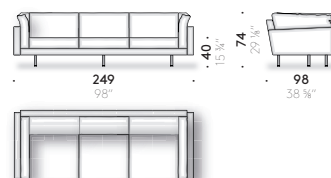
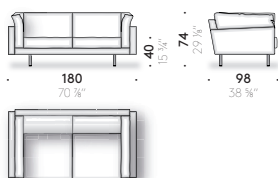

Elementi componibili

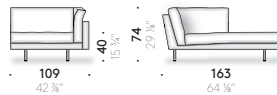
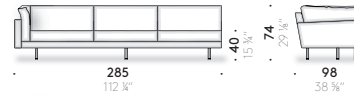
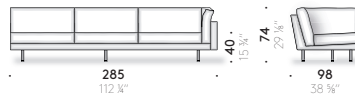
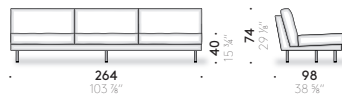
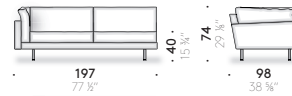
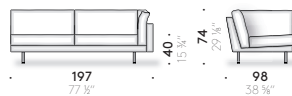
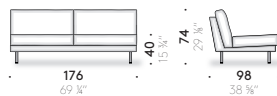
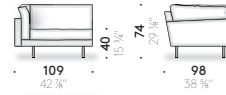
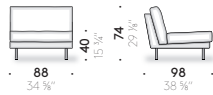
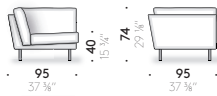
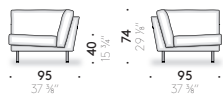

Esempi di composizione

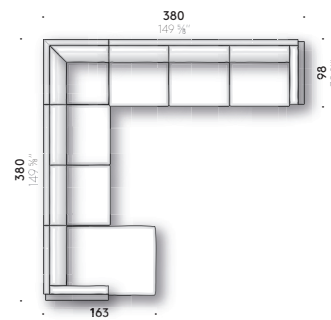
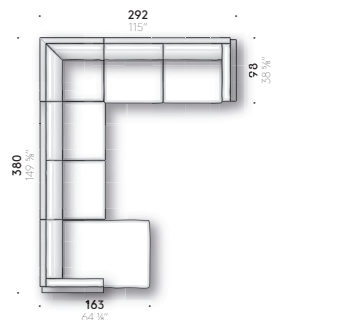
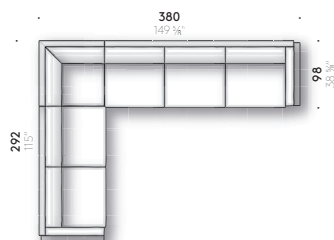
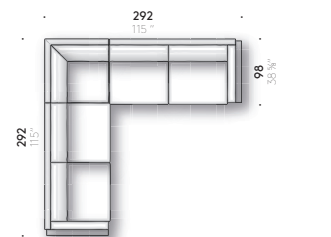
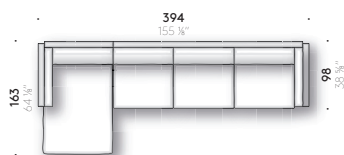
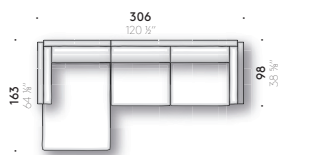

## Square 16 2004 / 2016



### Modular, straight sofa and pouf

#### Materials

FRAME: steel and wood with elastic straps.

FEET: powder-coated steel, gun barrel grey coloured or in solid ash, Canaletto walnut stained, finished with transparent water-based or solvent-based coating. Adjustable thermoplastic glide feet.

PADDING: variable-density polyurethane foam and polyester wadding covered with light polyester velvet. For the FR (Fire Resistant) versions on request, the filling materials comply with the current regulations.

GOOSE DOWN VERSION: seat cushion in goose down with polyurethane foam structure, covered with polyester wadding and cotton cloth. Armrest cushion in goose down with polyurethane foam structure, covered with cotton cloth. Backrest cushion in goose down mixed with polyester fibres, covered with cotton cloth.

MEMORY FOAM VERSION: seat cushion in memory foam, polyurethane foam and polyester wadding, covered with cotton cloth. Backrest and armrest cushion in goose down mixed with polyester fibres, with polyurethane foam structure, covered with cotton cloth. Only for the UK market the components in memory foam are made of polyurethane foam.

COVER: technically removable cover in fabric or non-removable in leather or velvet.

+info:

<http://www.depadova.com/materials.pdf>

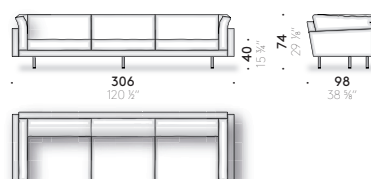
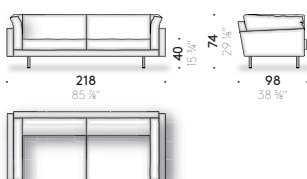
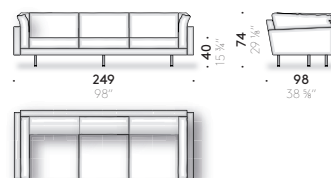
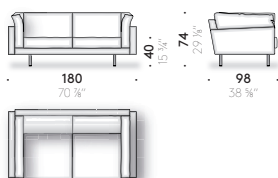

Modular elements

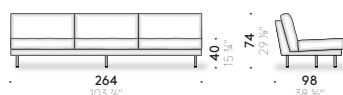
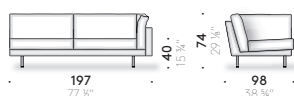
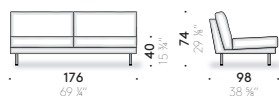
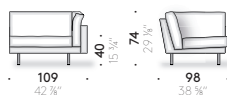
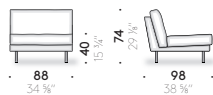
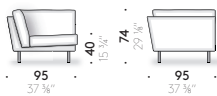
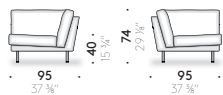

Composition Examples

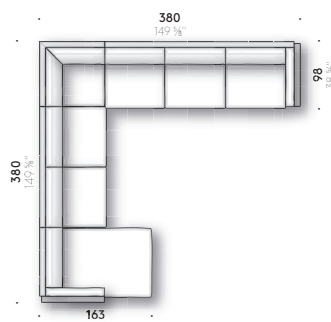
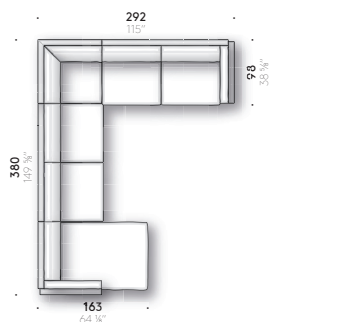
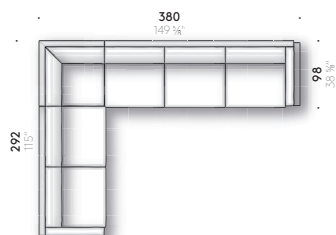
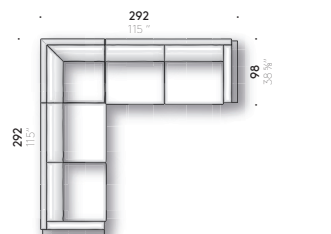
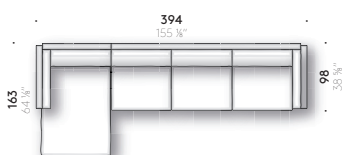
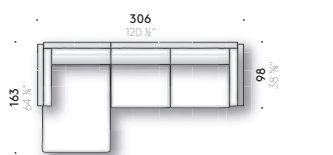

## Square 16 2004 / 2016



### Canapé droit modulable et pouf

#### Matériaux

STRUCTURE: acier et bois avec sangles élastiques.

PIEDS: acier peint à poudre couleur canon de fusil ou bois massif de frêne teinté noyer noir canaletto fini avec peinture transparente à base d'eau ou à base de solvant. Patin réglable en thermoplastique.

REMOBOURRAGE: mousse de polyuréthane à densité variable et ouate de polyester doublée en velours de polyester. Pour les versions FR (Fire Resistant) sur demande, les matériaux du rembourrage sont conformes aux réglementations.

VERSION PLUME D'OIE: coussin d'assise en plume d'oie avec support en mousse de polyuréthane, doublé en ouate de polyester et toile de coton. Coussin accoudoir en plume d'oie avec support en mousse de polyuréthane, doublé en toile de coton. Coussin dossier en plume d'oie mixte en fibre de polyester, revêtu en toile de coton.

VERSION MEMORY FOAM: coussin d'assise en memory foam, mousse de polyuréthane et ouate de polyester, doublé en toile de coton. Coussin dossier et accoudoir en plume d'oie mixte à fibre de polyester avec support en mousse de polyuréthane, doublé en toile de coton. Uniquement pour le marché UK les parties prévues en memory foam sont réalisées en mousse polyuréthane.

REVÊTEMENT: revêtement techniquement déhoussable en tissu ou fixe en cuir ou velours.

+info:

<http://www.depadova.com/materials.pdf>

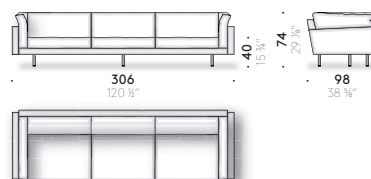
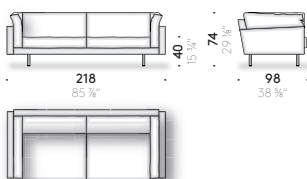
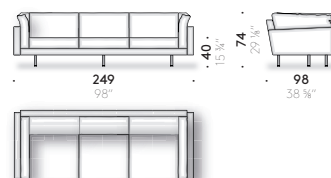
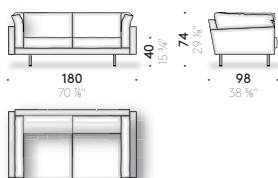

Éléments modulaires

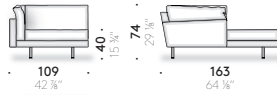
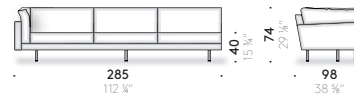
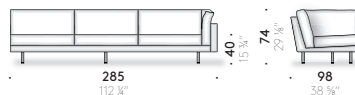
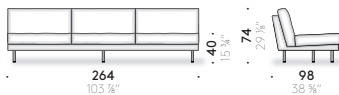
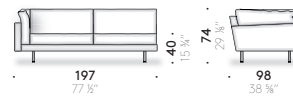
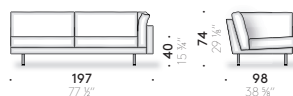
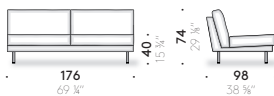
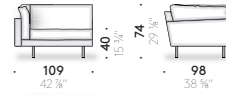
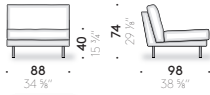
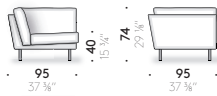
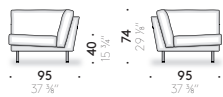

Exemples de composition

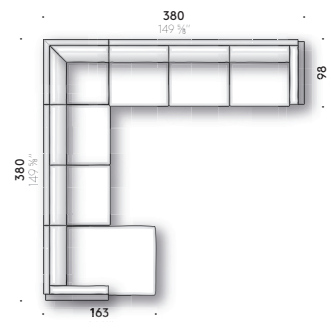
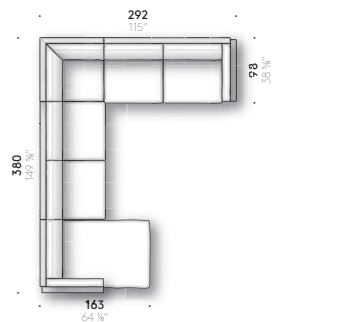
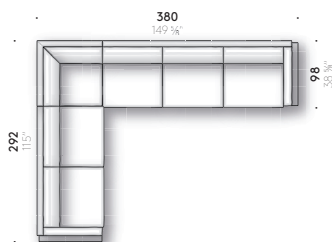
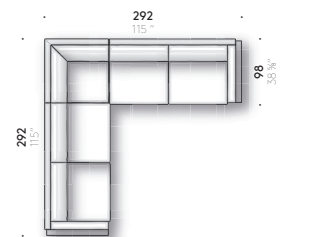
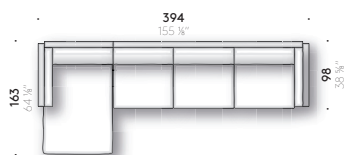
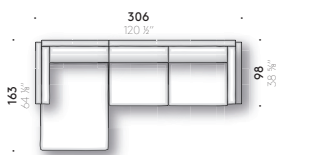

## Square 16 2004 / 2016



### Gerades und modulares Sofa und Puff

#### Materialien

GESTELL: Stahl und Holz mit elastischen Gurten.

FÜSSE: Stahl mit Pulverlackierung metallgrau oder in massive Esche gebeizt Nussbaum Canaletto, endbehandelt mit transparentem Lack auf Wasser- oder Lösemittelbasis. Verstellbarer Thermoplast-Gleitfuß.

POLSTERUNG: Polyurethanschaum unterschiedlicher Dichte und Polyesterwatte, mit Überzug aus Polyestersamt. Bei den FR-Versionen (Fire Resistant), die auf Anfrage erhältlich sind, entsprechen die Polstermaterialien den geltenden Bestimmungen.

VERSION MIT GÄNSEDAUNEN: Sitzkissen in Gänsedaunen mit Polyurethanschaumkern, mit Überzug aus Polyesterwatte und Baumwollgewebe. Armlehnenkissen in Gänsedaunen mit Polyurethanschaumkern, mit Überzug aus Baumwollgewebe. Rückenlehnenkissen in Gänsedaunen gemischt mit Polyesterfaser, mit Überzug aus Baumwollgewebe.

VERSION MIT MEMORY-SCHAUM: Sitzkissen in Memory Schaum, Polyurethanschaum und Polyesterwatte mit Überzug aus Baumwollgewebe. Rücken- und Armlehnenkissen in Gänsedaunen gemischt mit Polyesterfaser mit Polyurethanschaumkern, mit Überzug aus Baumwollgewebe. Nur für den britischen Markt sind die in Memory-Schaum vorgesehenen Teile aus Polyurethanschaum hergestellt.

BEZUG: technisch abnehmbarer Stoffbezug oder fester Leder- oder Samtbezug.

+info:  
<http://www.depadova.com/materials.pdf>

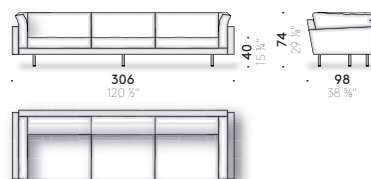
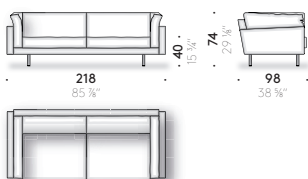
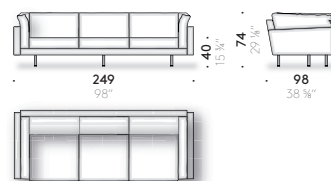
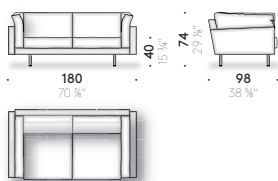

Modulare Elemente

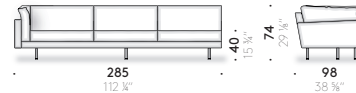
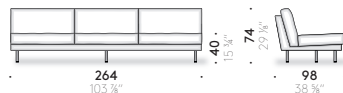
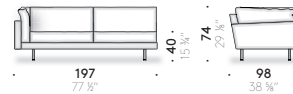
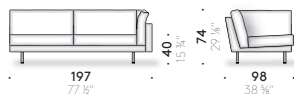
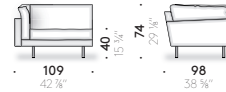
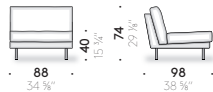
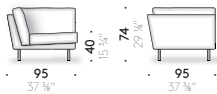
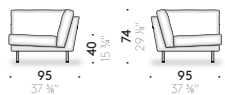

Kompositionsbeispiele

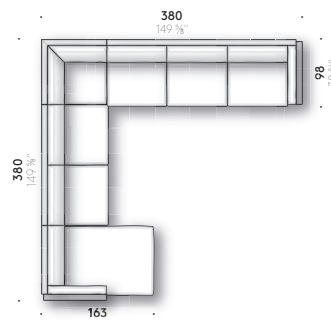
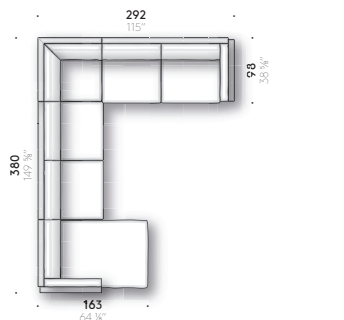
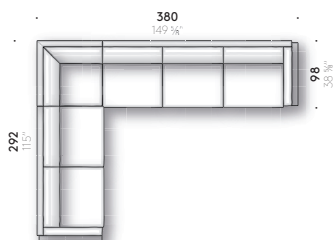
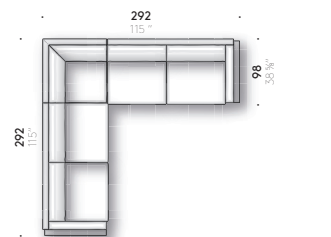
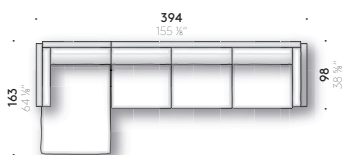
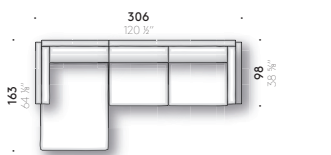



## Square 16 2004 / 2016



### Sofá lineal modular y puf

#### Materiales

ESTRUCTURA: acero y madera con cinchas elásticas.

PIES: acero pintado en polvo color gris plomo o madera maciza de fresno teñido nogal negro "canaletto" acabado con barniz transparente al agua o al disolvente. Bajo-pie ajustable de material termoplástico.

RELLENO: espuma de poliuretano de densidad diferente y guata de poliéster tapizadas con terciopelo de poliéster. Para las versiones FR (Fire Resistant) bajo pedido, los materiales del relleno cumplen con las normativas.

VERSIÓN PLUMA DE OCA: cojín de asiento de plumas de oca con soporte de espuma de poliuretano, tapizada con guata de poliéster y tela de algodón. cojín brazo de plumas de oca con soporte de espuma de poliuretano, tapizado con tela de algodón. Cojín de respaldo de plumas de oca mezclada con fibra de poliéster, tapizado con tela de algodón.

VERSIÓN MEMORY FOAM: cojín de asiento en memory foam, espuma de poliuretano y guata de poliéster, tapizada con tela de algodón. Cojín de respaldo y brazo de plumas de oca mezclada con fibra de poliéster con soporte de espuma de poliuretano, tapizada con tela de algodón. Solo para el mercado UK las partes previstas en memory foam están hechas de espuma de poliuretano.

REVESTIMIENTO: revestimiento técnicamente desenfundable de tejido o fijo de piel o terciopelo.

+info:

<http://www.depadova.com/materials.pdf>

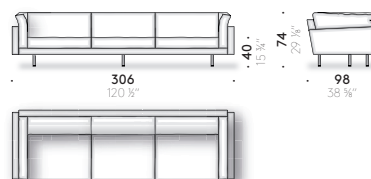
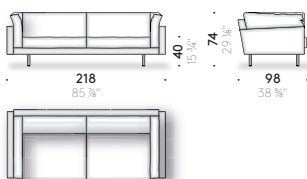
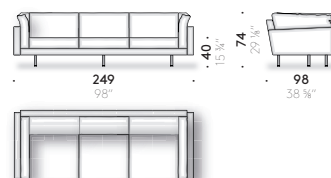
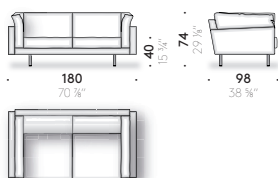

Elementos componibles

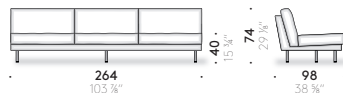
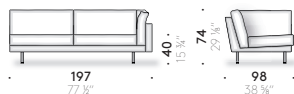
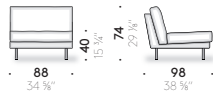
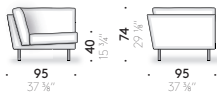
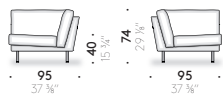

Ejemplos de composición

